

All stainless steel pressur gauges with Bourdon tube with or without glycerine filling

Nominal size ND 63
Accuracy class 1.6

according to DIN EN 837-1

Features

Ideal for hard conditions
High reliability on a longterm basis
Stainless steel case and measuring system
Overange protection 1,3 times max.
Protection IP 54 resp.IP 65 (filled)



Applications

Chemical and petrochemical industry
Foodstoffs and beverages industry
Paper industry

	with glycerine filling			
Models and ND	MR-30 63	MR-35 63	MR-30 63 F	MR-35 63 F
Connections	bottom	back,eccentric	bottom	back,eccentric
Ranges in bar	0...1, 1,6, 2,5, 4, 6, 10, 16, 25, 40, 60, 100, 160, 250, 400, 600, 1.000 -1 / 0, -1 / +0,6, -1 / +1,5, -1 / +3, -1 / +5, -1 / +9, -1 / +15			
Application	Constant load : up to full scale value Alternating load : up to 0,9 x full scale value Overange protection 1,3 times max.			
Case	CrNi steel			
Bezel	CrNi steel			
Window	Lamineted safety glass			
Dial	Aluminium , white ,scale and imprint black			
Pointer	Aluminium, black			
Movement	CrNi steel			
Measuring element	CrNi steel ,Bourdon tube <40 bar, helical tube > 60 bar,			
Connection	CrNi steel			
Connectionthread	G 1/4 B			
Protection	IP 65 to EN 60529 / IEC 529			
Temperature drift	Medium: -20°C bis 80°C, Ambient : -25°C bis 60°C			
Weight	0,2 kg		0,25 kg	

Dimensions

Connection bottom

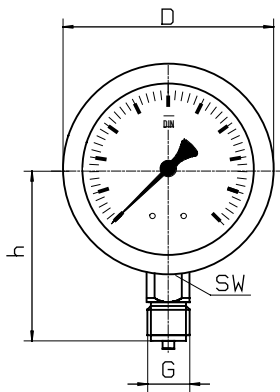

front flange

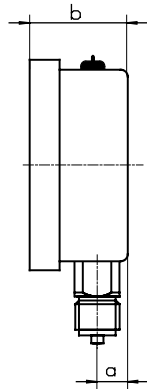

rear flange

Connection back, eccentric

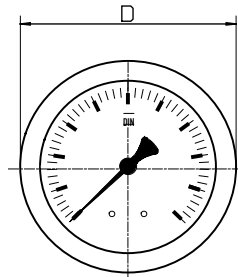

front flange

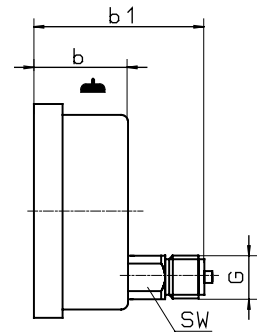

with triangle
bezel a.U-clamp

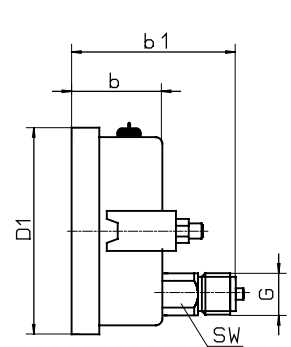
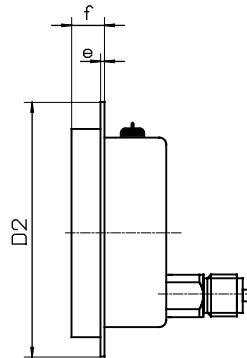
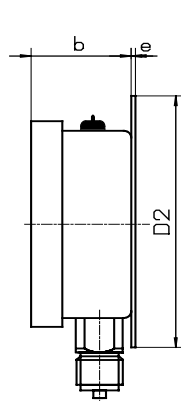
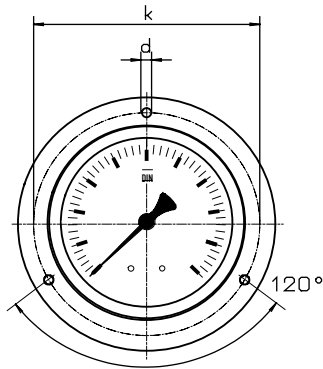

Dimensions in mm														
Model	NG	D	a	b	b1	h		D2	e	f	k	d	sw	G
MR-30	63	68,5	9,5	31	-	53		85	3	16	75	3,7	14	G 1/4 B
MR-35	63	68,5	-	31	60	-		85	3	16	75	3,7	14	G 1/4 B
MR-30 F	63	68,5	9,5	31	-	53		85	3	16	75	3,7	14	G 1/4 B
MR-35 F	63	68,5	-	31	60	-		85	3	16	75	3,7	14	G 1/4 B

Modelspecification

